

# Introduction to Chromatography

By  
**Dr Stephen Summerfield**  
Department of Chemistry

**April 2010**



This work is licensed under a Creative Commons Attribution-Non-Commercial-No Derivative Works 2.0 – UK: England & Wales License.  
<http://creativecommons.org/licenses/by-nc-nd/2.0/uk/>

**Analytical Chemistry Techniques: Overview**

This is part three of four separate techniques guides that provide introductions to different aspects of analytical chemistry:

**Part 1: Introduction to Analytical Chemistry:**

A basic introduction to analytical science in general, and analytical chemistry in particular, including an overview of the analytical process, quality assurance, and guidance on solution preparation including volumetric and concentration calculations. It also includes a bibliography of useful texts for the analytical chemist.

**Part 2: Introduction to Molecular Spectroscopy:**

An introduction to the different types of molecular spectroscopic analysis, including UV-Vis, fluorescence, IR, MS and NMR, describing the basic principles of each technique and practical considerations including sample preparation. It is illustrated with simple diagrams, photographs of equipment and information to aid interpretation of spectra.

**Part 3: Introduction to Chromatography:**

An introduction to chromatographic analysis, describing the different types of chromatography, including TLC, GC, HPLC and ion chromatography, their application areas and basic principles of operation. It is illustrated with simple diagrams, photographs of equipment and chromatograms illustrating practical aspects of the technique.

**Part 4. Introduction to Atomic Spectrometry:**

An introduction to the different types of atomic spectrometric analysis, including ICP-AES, ICP-MS, XRF and AAS, describing the basic principles of each technique, their application areas and modes of operation, including practical comparison of the techniques. It is illustrated with simple diagrams and photographs of equipment.

**Contact Details**

Dr. Stephen Summerfield [s.summerfield@lboro.ac.uk](mailto:s.summerfield@lboro.ac.uk)  
Dr. Helen Reid [h.j.reid@lboro.ac.uk](mailto:h.j.reid@lboro.ac.uk)

Author (s)	Stephen Summerfield & Helen Reid
Owner (s)	Loughborough University
Title	Introduction to Chromatography
Classification	F180, Analytical Chemistry
Keywords	ukoer, sfsoer, chromatography, separations, TLC, GC, GLC, GC-MS, HPLC, ion chromatography, IC, IEC
Description	An Introduction to Chromatographic Analysis, describing the different types of chromatography, their application areas and basic principles of operation. It is illustrated with simple diagrams, photographs of equipment and chromatograms illustrating practical aspects of the technique.
Creative Commons licence (url)	<a href="http://creativecommons.org/licenses/by-nc-nd/2.0/uk/">http://creativecommons.org/licenses/by-nc-nd/2.0/uk/</a>
Language	English
File size	1.7 MB (1.62 MiB)
File format	pdf

## Contents

Contents	3
Tables	3
Figures	3
Chapter 1 Chromatography	4
1.1 The chromatogram	5
1.2 Retention Factor	5
1.3 Peak efficiency	6
Chapter 2 Thin Layer Chromatography	7
2.1 Identification	8
2.2 Advanced TLC	9
Chapter 3 Gas Chromatography	10
3.1 Instrumentation	11
3.2 Columns	13
3.3 Changing parameters	14
3.4 Detectors	16
3.5 Quantitative Analysis	17
3.6 Identification	18
Specialised Techniques	18
Chapter 4 GC MS	20
Chapter 5 High Performance Liquid Chromatography	23
5.1 Instrumentation	23
5.2 HPLC columns	25
5.3 Detectors	27
Chapter 6 Ion Exchange Chromatography	28
6.1 Separation of Mixtures using Ion-Exchange	28
6.2 Ion Chromatography	29

## Tables

Table 1: Classification of chromatographic methods	4
Table 2: TLC of some drugs using silica gel plates	9
Table 3: Packed GC Columns	13
Table 4: Capillary GC Columns	13
Table 5: GC Detectors	16
Table 6: HPLC Detectors	27

## Figures

Figure 1: Chromatogram.	5
Figure 2: Chromatographic separations	5
Figure 3: Peak Efficiency	6
Figure 4: Example of a TLC	8
Figure 5: Schematic diagram of a Gas Chromatograph	11
Figure 6: Optimal Gas Flow Rate for GLC.	14
Figure 7: Influence of temperature on separation for GLC.	15
Figure 8: Sensitivity of GC Detectors	16
Figure 9: A schematic diagram of a HPLC	23
Figure 10: Selection of mobile phase for reversed-phase HPLC.	26
Figure 11: Sensitivity of HPLC Detectors	27
Figure 12: Ion Chromatograph	30

# Chapter 1

## Chromatography

Chromatography is a separation technique. The components of a mixture are distributed between two phases, the stationary phase and the mobile phase. The mobile phase moves through or over the surface of the fixed (stationary) phase. The components of the mixture have different affinities for each phase, hence some are retained longer on the stationary phase than others causing separation.

The retention of a component is determined by the chemical and physical properties of the two phases and the experimental conditions (temperature and pressure). Therefore, pure reference materials must be chromatographed under the same conditions as the test samples. Following chromatography, the identity of the compounds must be substantiated by other analytical methods.

The most common chromatographic methods are:

1. Paper Chromatography
2. Thin Layer Chromatography (TLC)
3. High Performance Liquid Chromatography (HPLC)
4. Gas Liquid Chromatography (GLC)

**Table 1: Classification of chromatographic methods**

		Stationary Phase	Mobile Phase	Sorption Mechanism	Principal Applications
<b>Planar Chromatography</b>					
Paper Chromatography	PC	Paper (cellulose)	Liquid	Partition	Analysis of mixtures
Thin Layer Chromatography	TLC	Silica, cellulose, ion exchange resin, controlled porosity solid	Liquid	Adsorption	Analysis of mixtures
<b>Liquid Chromatography</b>					
High performance liquid chromatography	HPLC	Solid or bonded phase	Liquid	Modified partition	Determination of non-volatile compounds
Ion Exchange Chromatography Ion Chromatography	IEC IC	Ion exchange resin or bonded phase	Liquid	Ion Exchange	Determination of non-volatile anions and cations.
Size Exclusion Chromatography Gel Permeation Chromatography Gel Filtration Chromatography	SEC GPC GFC	Controlled porosity solid such as silica or polymeric gel	Liquid	Exclusion	Determination of peptides, proteins and polymers
Chiral Chromatography	CC	Solid chiral selector or pre-column chiral reactions	Liquid	Selective adsorption	Separation and determination of chiral compounds
<b>Gas Chromatography</b>					
Gas Liquid Chromatography	GLC	Liquid phase on a wall or solid support	Gas	Partition	Determination of volatile compounds or gasses

## 1.1 The chromatogram

This is a two-dimensional trace with time as the x-axis and detector response on the y-axis. The separation occurring on the column leads to a series of peaks that are resolved from the *baseline* (the absence of analyte).

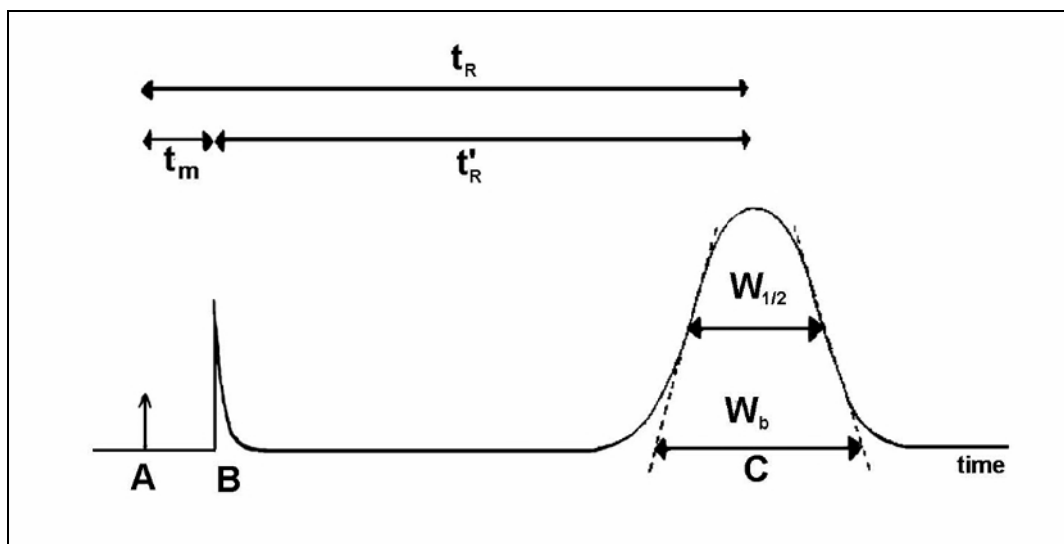

Figure 1: Chromatogram. Where A = injection, B = solvent peak and C = peak of interest

A constituent is characterised by its **Retention Time** ( $t_R$ ) defined as the time taken between the injection and the maximum recorded on the chromatogram. A compound not retained will elute out of the column at  $t_M$ , called the **dead** or **void time**.

The **adjusted retention time** of a component ( $t_R'$ ) is given by  $t_R - t_m$ . In quantitative analysis, it is sufficient to separate only those components, which are required.

## 1.2 Retention Factor

This was originally known as Capacity Factor  $k'$ . The larger the  $k'$ , the longer the retention time.

$$k' = \frac{t_R - t_m}{t_m}$$

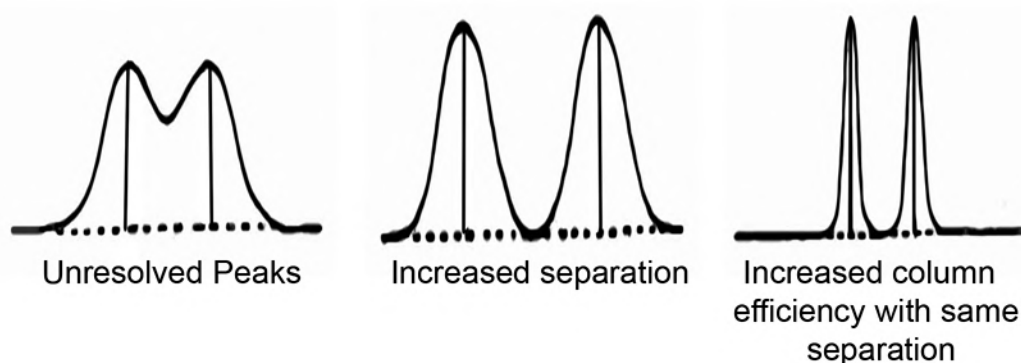

Figure 2: Chromatographic separations

### 1.3 Peak efficiency

The number of theoretical plates (N) is a measure of the efficiency of a column.

$$N = 16 \left[ \frac{t_R}{W_b} \right]^2 = 5.54 \left[ \frac{t_R}{W_{1/2}} \right]^2$$

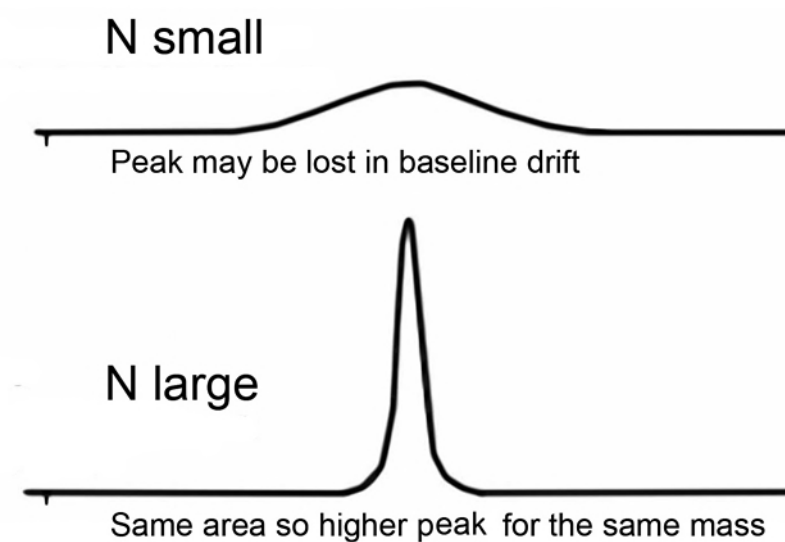

Figure 3: Peak Efficiency

## Chapter 2

# Thin Layer Chromatography

TLC is used primarily for the tentative identification of dyes, pigments and screening for drugs (e.g. opiates, cocaine, amphetamines, barbiturates, and cannabis). It is simple and cheap to perform. A thin-layer chromatography (TLC) system consists of a finely divided particulate stationary phase immobilised as a thin layer on a plate, and a liquid mobile phase consisting of an organic solvent or mixture of solvents. The liquid sample or dissolved sample in a volatile solvent, is deposited as a spot on the stationary phase. The mixture is separated as it moves through a thin layer of stationary phase (silica gel or aluminium oxide spread on glass, aluminium or plastic sheets) by the migrating solvent (mobile phase). The polarity of the compound determines the relative positions of the components upon the TLC plate. Reversed-phase TLC using a polar eluent on a non-polar stationary phase is a useful method to try out separations that could then be carried out by reversed-phase HPLC.

**Stationary Phase** - Silica gel, alumina, cellulose, ion exchange resins and chiral selectors coated to a depth of 0.15-0.5 mm on glass, aluminium or plastic sheets (varying in size from 20 cm by 20 cm plates to microscope slides).

**Mobile Phase** - Single solvents or mixtures of two or more solvents having the appropriate polarity to get the required separation ranging from non-polar (hydrocarbons) to polar solvents (alcohols, water, acids and bases).

**Separation** - The prepared plate is developed in a closed, pre-saturated chamber using an ascending mobile solvent flow. A pencil line is drawn about 1 cm from the edge of the TLC plate. About 5-20 microlitres of each sample is then applied in a volatile solvent to a point along this line taking care not to disturb the surface of the stationary phase. The solvent is then evaporated before development by placing the plate in the mobile phase at a level below the applied sample. When the solvent front nears the top edge of the stationary phase after 15 minutes up to several hours, the plate is removed from the solvent reservoir.

The sample ascends the plate by capillary action of the mobile phase and the various components of the sample are retarded in proportion to their interaction with (sorption on) the sorbent bed, i.e. the sample partitions between the two phases. At any given time, a particular solute molecule is either in the mobile phase, moving along at its velocity, or in the stationary phase and not moving at all. The sorption-desorption process occurs many times as the molecule moves up the plate, and the time to do so depends primarily on the length of time it is sorbed and held immobile. A separation is effected as the various components travel up the plate.

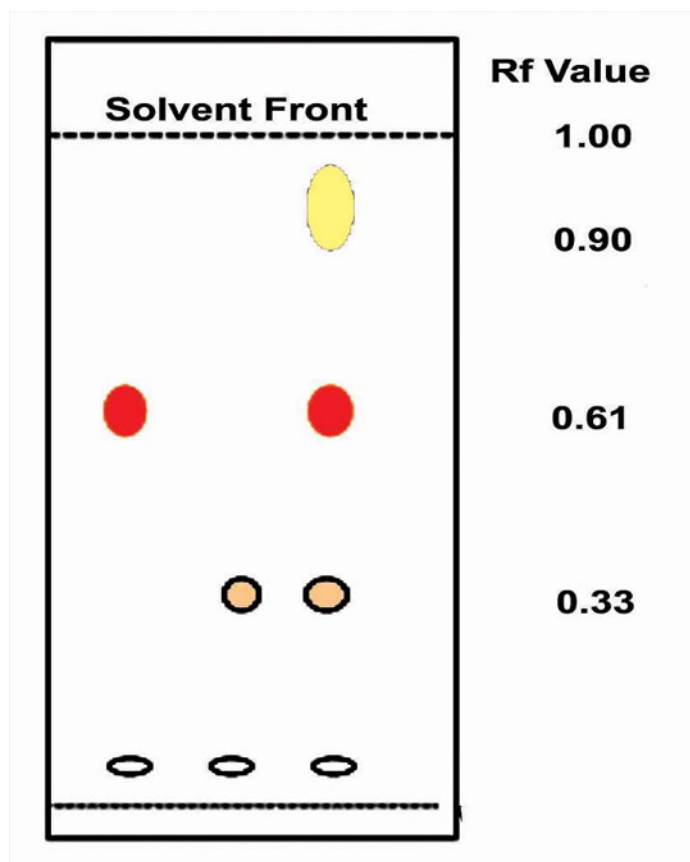

Figure 4: Example of a TLC plate

## 2.1 Identification

The constituents of a sample are identified by simultaneously running standards with the unknown. After development is complete and the plate dried, the solute bands must be located using one of the following methods:

1. Visual identification
2. Fluorescent components on non-fluorescent plates seen under UV light
3. Chemical reaction to produce coloured complexes after spraying with specific reagents (e.g. ninhydrin for amino acids)
4. Fluorescent indicator incorporated into the stationary phase aids visualisation of spots under UV light where the separated compounds are seen as dark spots upon the fluorescent background.
5. Spraying with a developer to produce visual spots such as concentrated sulphuric acid and heat or iodine.

A measure of the progress of each spot up the plate is given by the  $R_f$  value calculated as:

$$R_f = \frac{\text{distance a solute migrates up plate}}{\text{distance the solvent front migrates up plate}}$$

The  $R_f$  values are always equal to, or less than, unity because a solute cannot migrate farther than the solvent front. The more a sample is retarded by the stationary layer, the smaller its  $R_f$  value will be. Thus the  $R_f$  value of any solute can be used as a qualitative index for its identification under specified chromatographic conditions.



Comparing the  $R_f$  value of the sample to the standard allows identification. Plate scanners and densitometers allow quantification of the spots. Confirmation could be performed by doing preparative TLC on another plate followed by FT-IR or mass spectroscopy.

**Table 2: TLC of some drugs using silica gel plates and mobile phase of 17:2:1 ethyl acetate: methanol: concentrated ammonium hydroxide.**  
[Davidow et al. (1968) *Am. J. Clin. Pathol.*, 38, 714]

Drug	$R_f$	Visualisation technique				
		ninhydrin	diphenyl-carbazone in mercuric sulphate	heat	UV light	iodoplatinate
Morphine	0.15					blue
Phenylpropanolamine	0.27	red				light brown
Codeine	0.30					
Quinine	0.38				blue	
Amphetamine	0.39	pink				
Phenobarbital	0.53		purple			
Amobarbital	0.75		purple			
Chlorpromazine	0.78			red	brown	brown
Thioridazine	0.78			blue		dark brown
Diazepam	0.88				yellow green	red brown
Amitriptyline	0.98				blue	light brown

## 2.2 Advanced TLC

**Automated TLC** is where solvent flow is forced by running the plate in a vacuum-capable chamber to dry the plate, and recording the finished chromatogram by absorption or fluorescence spectroscopy with a light source. The ability to program the solvent delivery makes it convenient to do multiple developments in which the solvent flows for a short period of time, the TLC plate is dried, and the process is repeated. This method refocuses the spots to achieve higher resolution than in a single run.

**Two-dimensional TLC** uses the TLC method twice to separate spots that are unresolved by only one solvent. After running a sample in one solvent, the TLC plate is removed, dried, rotated 90° and run in another solvent. Any of the spots from the first run that contain mixtures can now be separated. The finished chromatogram is a two-dimensional array of spots.

## Chapter 3 Gas Chromatography

This is a powerful and rapid analytical tool for identification and quantification of almost any compound volatile below 450°C. It can cope with very complex mixtures (a hundred or more components) and very small samples (ng), with relative precision of 2 to 5%. GC is used in organic analysis of petrochemicals, pharmaceuticals, forensic, and environment samples.

Gas liquid chromatography (GLC) separates volatile organic compounds on columns containing a liquid stationary phase on a solid support.



**GC syringes for manual injection**

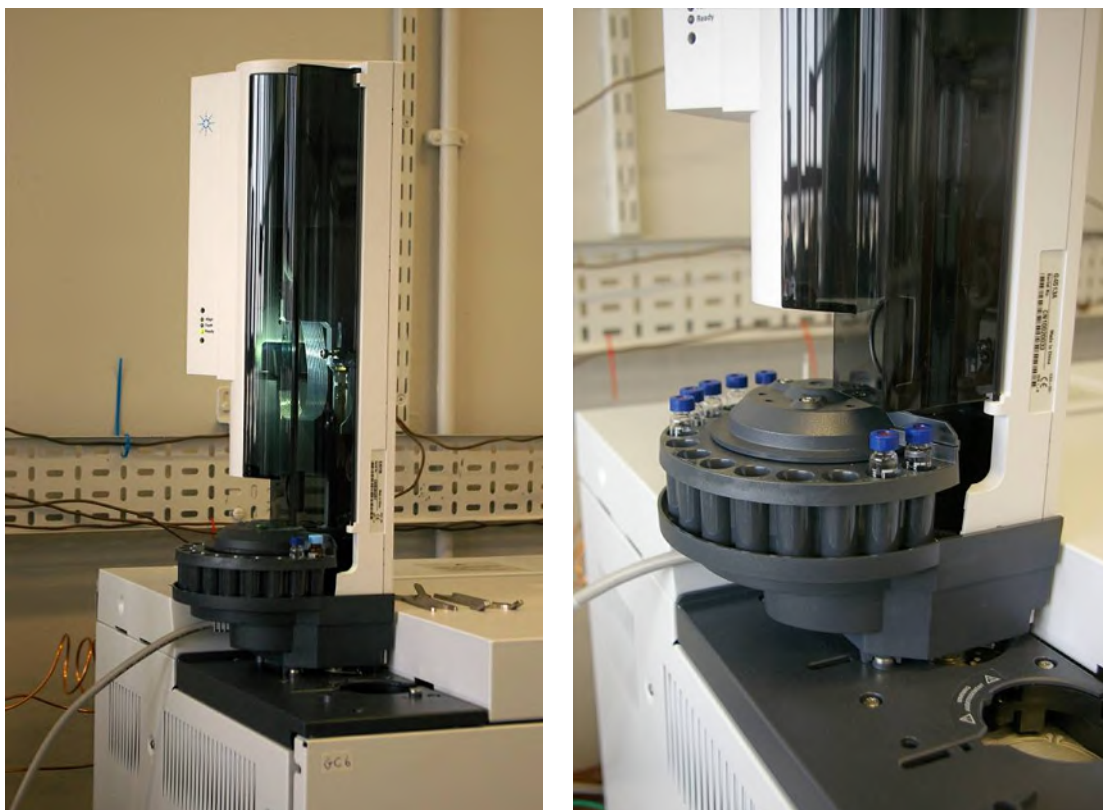

**Autosampler for the Agilent 7820A GC System**

### 3.1 Instrumentation

A gas chromatograph consists of a mobile phase (carrier gas), an injection port, a separation column containing the stationary phase, and a detector (as shown in Figure 5). The organic compounds are separated due to differences in their partitioning behaviour between the mobile gas phase and the stationary phase in the column. The injector vaporises the analytes and mixes them uniformly with the mobile phase (nitrogen or helium). Once the sample is vaporised, it is swept into the column, which is contained in a variable temperature oven. At the end of the column, the mobile phase passes through a detector before it exits to the atmosphere.

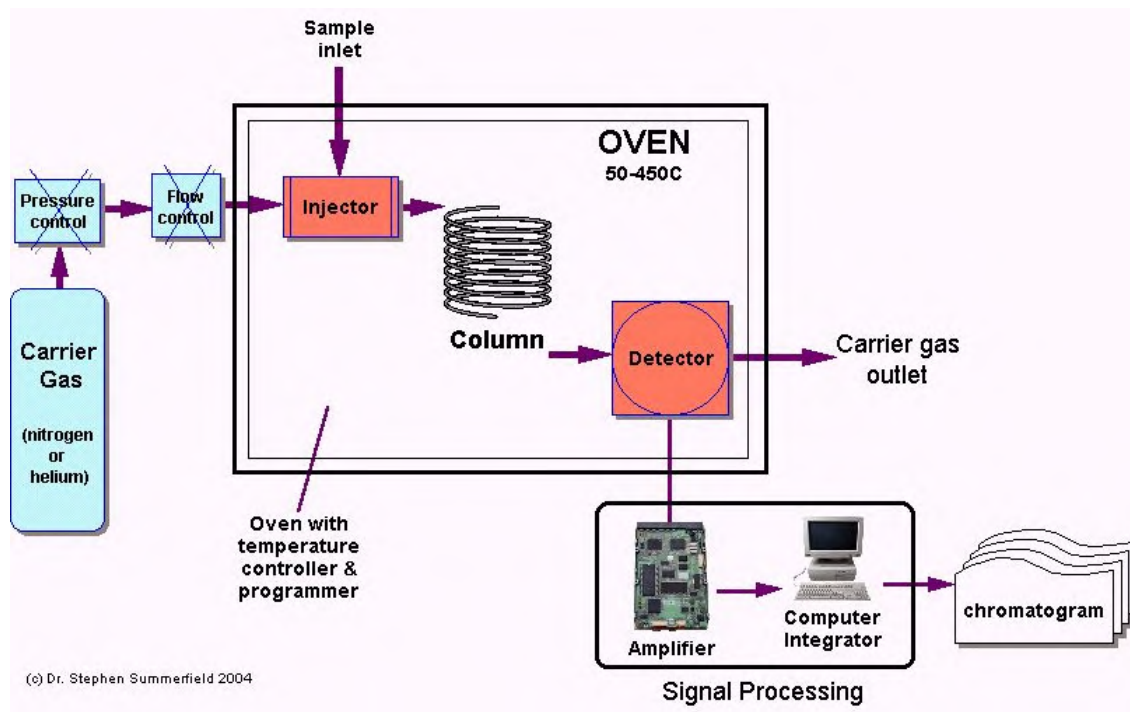

**Figure 5: Schematic diagram of a Gas Chromatograph**

Carrier gas	Inert gas (N <sub>2</sub> , H <sub>2</sub> or He) used to move the sample through the column.
Flow control	Maintains constant flow through the column.
Injector	Introduces and vaporises the sample.
Oven	Thermostatically controlled oven either isothermal (same temperature) or temperature programmed to separate components with a wide range of boiling points.
Column	Tubing containing the stationary phase coated either on an inert solid support or on the column.
Detector	Detects sample components as they elute from the column.

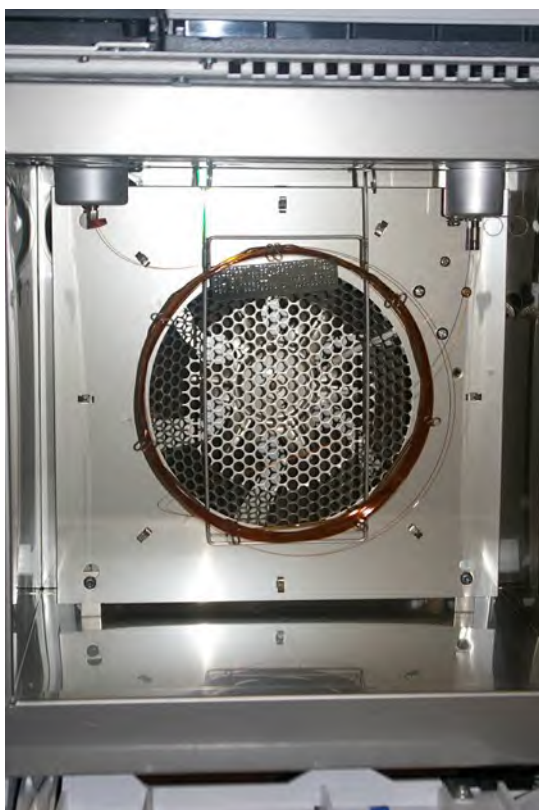

**Agilent 7820A GC System**  
**GC System (top left),**  
**close-up of the Controller (top)**  
**and inside the oven (left)**

### 3.2 Columns

The most common stationary phases are modified polysiloxanes with different polarities from the non-polar polydimethyl siloxane that can be made more polar by increasing the percentage of phenyl groups on the polymer to the polar polyethylene glycol (carbowax).

**Table 3: Packed GC Columns**

<b>Packed Columns</b>	<p>1-3 m stainless steel or glass columns (2-4 mm ID) packed with a porous inert support on which the stationary phase is deposited (3-25%). Used primarily for routine analysis and not trace analysis.</p> <ul style="list-style-type: none"> <li>• Limited efficiency and resolving power for up to 20 components.</li> <li>• N<sub>2</sub> carrier flow rate = 10-40 ml/min.</li> <li>• Sample capacity 0.1-20 µl.</li> </ul>
-----------------------	---



**2 m Packed Column**



**10 m Capillary Column**

**Table 4: Capillary GC Columns**

<b>Narrow Bore Capillary Columns</b>	<p>15-100 m columns of thin fused silica (0.1-0.35 mm ID) with internal surfaces of the column treated or silanised, coiled around a lightweight metal support. Provides much higher separation efficiency than packed columns but are more easily overloaded by the sample.</p> <ul style="list-style-type: none"> <li>• Resolving power for up to 100 components.</li> <li>• He or H<sub>2</sub> carrier flow rate = 1-5 ml/min.</li> <li>• Sample capacity &lt; 0.1 µl.</li> </ul>
<b>Wide Bore Columns (megabore)</b>	<p>Made from 0.53 mm internal diameter silica tube with lengths varying from 5-50m. Carrier gas flow rates as high as 15 ml/min (helium). Sample capacity 0.1 to 10 µl.</p>

### 3.3 Changing parameters

Changing the carrier gas flow rate and the temperature influences the retention times of components as shown in Figure 6 and 7.

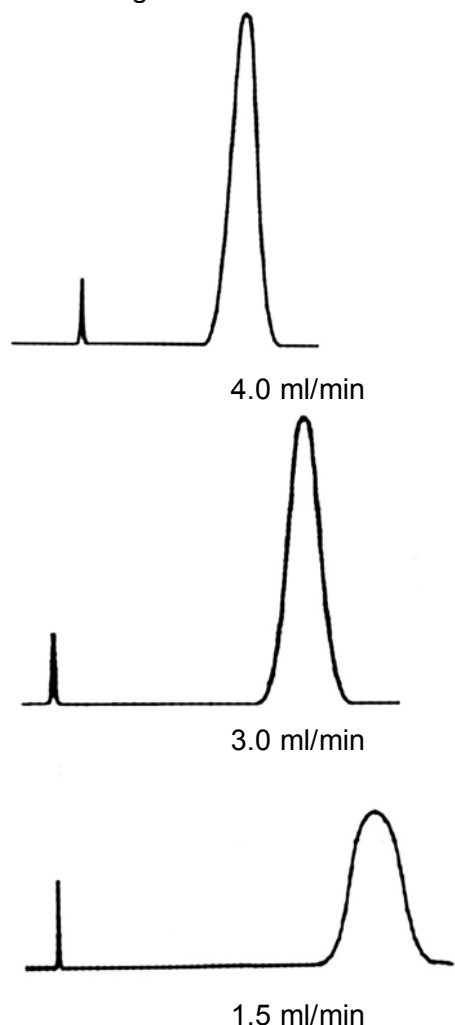

**Figure 6: Optimal Gas Flow Rate for GLC. Palmitic acid methyl ester injected onto a 0.5m 10% PEG (polyethylene glycol) column at 190 °C, nitrogen carrier gas and FID (flame ionisation detector) (S. Summerfield (1989), unpublished)**

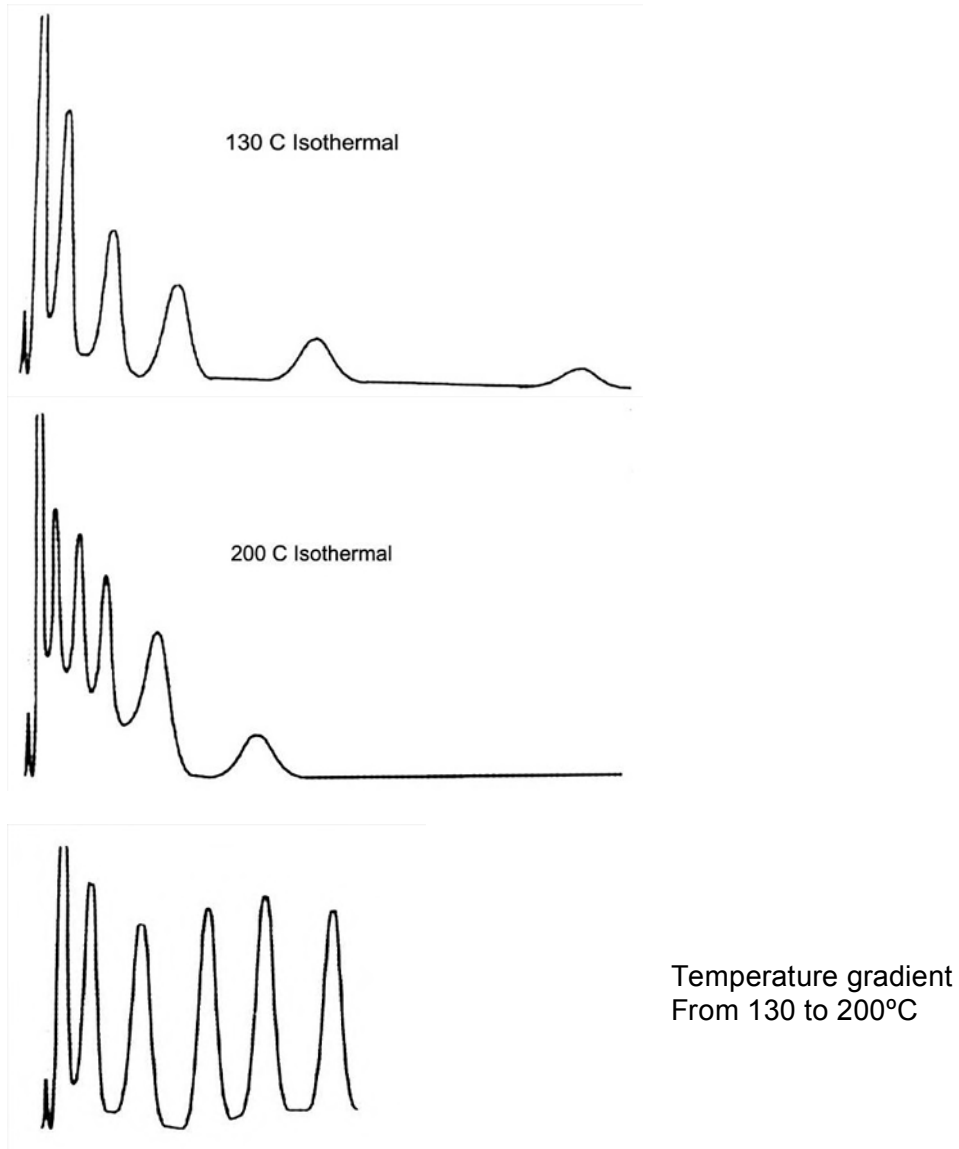

**Figure 7: Influence of temperature on separation for GLC. Mixture of methyl esters of C9-C13 fatty acids dissolved in heptane on an Apiezon column at various temperature conditions (S. Summerfield (1989), unpublished)**

### 3.4 Detectors

After the components of a mixture are separated using gas chromatography, they must be detected as they exit the GC column.

**Table 5: GC Detectors**

GC Detectors	Notes
Flame Ionisation Detector (FID)	The most common detector for the analysis of organic compounds. Used to determine hydrocarbons, alcohols, solvents and drugs due to its high sensitivity and large dynamic range ( $10^7$ ). The column effluent, mixed with hydrogen and air, is ignited electrically causing ionisation of organic compounds. A voltage is applied across the burner tip and the resulting current measured is proportional to the number of carbon atoms entering the detector per unit of time.
Thermal Conductivity Detector (TCD)	Universal detector but rarely used. Relies upon the thermal conductivity of gases. Not as sensitive as other detectors but is non-specific and non-destructive.
Electron Capture Detector (ECD)	Selective detector for halogens, organometallics, sulphur, phosphorus and aromatics. It does not detect aliphatics. Dynamic range $10^4$ .
Nitrogen Phosphorus Detector (NPD)	Very sensitive for nitrogen and phosphorus containing compounds.
Flame Photometric Detector (FPD)	Selective for phosphorus and sulphur containing compounds,
<b>Detectors yielding structural information</b>	
Mass Spectrometer (MS)	Very powerful, selective and sensitive method. A fragmentation spectrum of each eluting compound is produced, with the use of total ion current (TIC) monitoring. Specific compounds can be monitored by selective ion monitoring (SIM). A chromatogram is obtained that represents the compound eluting from the column.
Fourier Transform Infrared (FT-IR)	Selective detector, excellent for organic mixtures such as fragrances, solvents, carbonyls. Used for identification of degradation products and gives structural information about a wide variety of compounds. Used for the determination of biological materials.

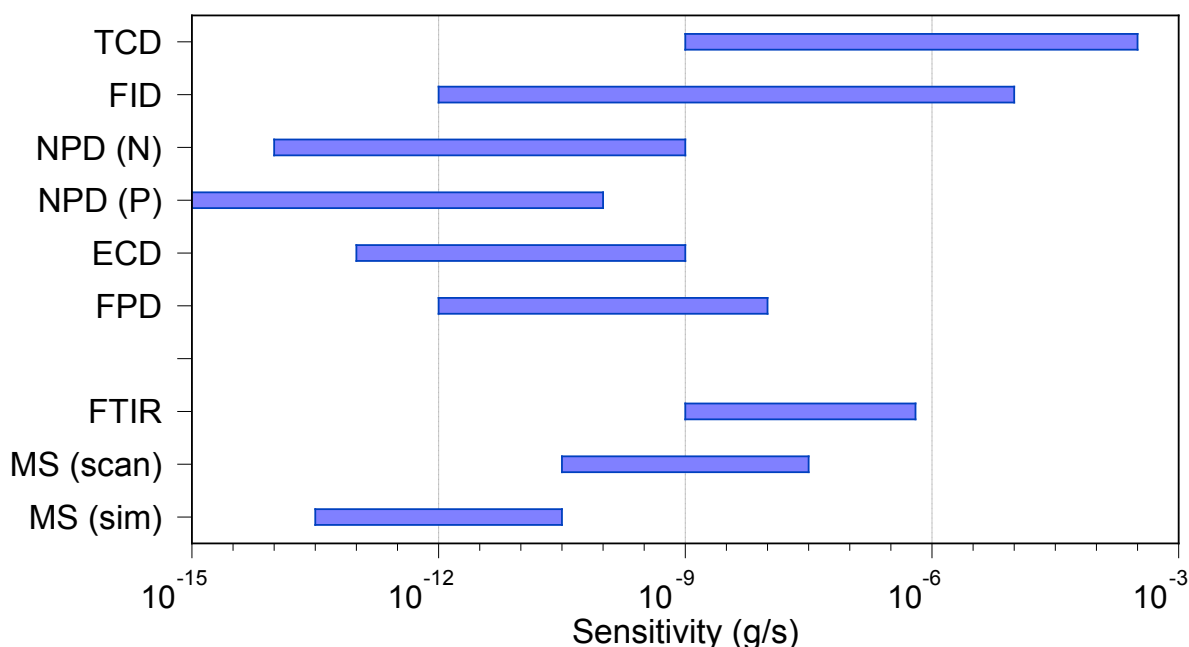

**Figure 8: Sensitivity of GC Detectors.**

[Derived from Kealey D. and Haines P.J. (2002), *Instant Notes: Analytical Chemistry*, BIOS Scientific Publishers Ltd]



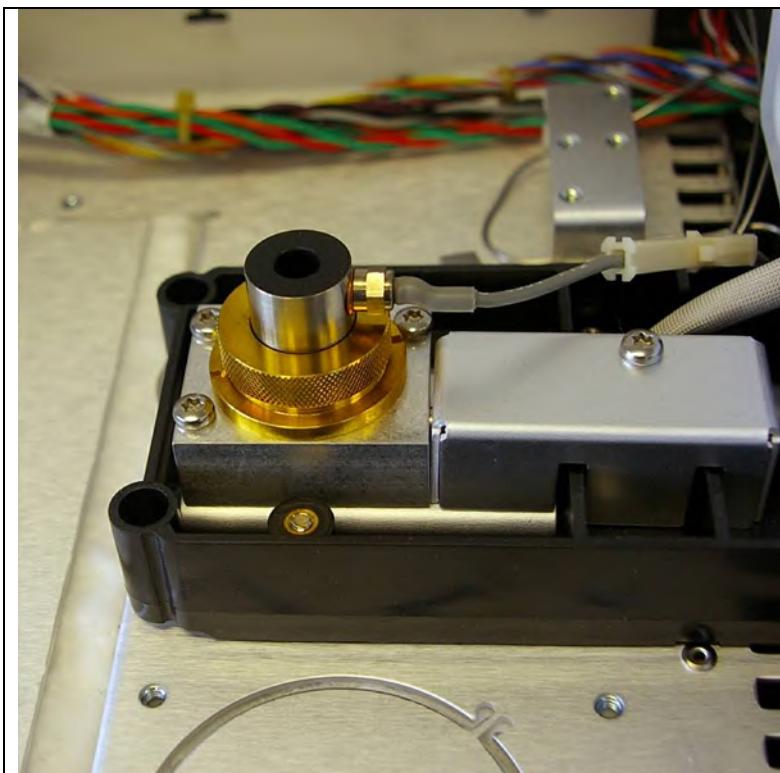

**FID of the Agilent  
7820A GC System**

### **3.5 Quantitative Analysis**

A series of samples containing a known concentration of the compound of interest (*calibration standards*) is analysed in order to calibrate the system. A calibration curve is obtained by plotting peak areas against analyte concentration and establishing the relationship between the two. Peak areas for unknown test samples are recorded (under the same experimental conditions as for the standards) and the calibration curve is used to predict the analyte concentration.

- **INTERNAL STANDARD:** Wherever possible the same amount of internal standard is added to the samples and calibration standards because injection volumes can be difficult to reproduce. The internal standard is usually a homologue of the analyte. The analyte peak area is measured relative to the internal standard to allow for any variation in injection volume. E.g. the propanol internal standard is used for ethanol determination.

### **3.6 Identification**

The constituents of a sample can be tentatively identified by comparison of retention times (i.e. time taken to pass through the column) with those of known standards run under the same conditions of temperature, carrier gas flow etc. However for pharmaceutical and forensic applications further structural information is required.

#### **Specialised Techniques**

**Pyrolysis GC** involves the rapid and controlled thermal decomposition of a few mg of the sample in the modified injection port, the volatile products then being swept into the column in a narrow band of carrier gas. The resulting pyrograms can be used as fingerprints of the original materials for identification purposes.

**Derivatisation** of non-volatile polar or thermally sensitive compounds to enhance their volatility and stability prior to chromatography is a well-established technique. Compounds containing hydroxyl, carboxyl and amino functional groups can be readily reactivated with appropriate reagents to convert these polar groups into much more volatile methyl, trimethylsilyl or trifluoroacetyl derivatives of greater volatility. Fatty acids, carbohydrates, phenols, amino acids and other compounds of biological interest are the most frequently derivatised, although HPLC is very often preferred for these compounds.

**Thermal desorption** is a technique that involves the pre-concentration of substances prior to chromatography. The sample vapours are allowed to pass through a small tube containing an absorbent such as Tenax or Poropak by atmospheric diffusion for a prescribed period of time. The tube is subsequently connected to the injection port of the GC and purged with carrier gas whilst being rapidly heated. This causes any previously absorbed substances to be thermally desorbed and swept onto the column in a narrow band to be separated in the normal manner.

**Headspace analyses** involves the examination of the vapours derived from a sample by warming in a pressurised partially filled and sealed container. After equilibration under controlled conditions, the proportion of volatile sample components in the vapours of the headspace are representative of those in the bulk sample. The system, which is usually automated to ensure satisfactory reproducibility, consists of:

- A thermostatically heated compartment in which batches of samples can be equilibrated
- The means of introducing small volumes of the headspace vapours, via positive pressure, into the carrier gas stream and then into the chromatograph.

The technique is particularly useful for samples that are mixtures of volatile and non-volatile components such as residual monomers in polymers, flavours and perfumes, and solvents or alcohol in blood samples, as the volatile analytes are separated from the involatile matrix giving a "clean" sample for analysis.

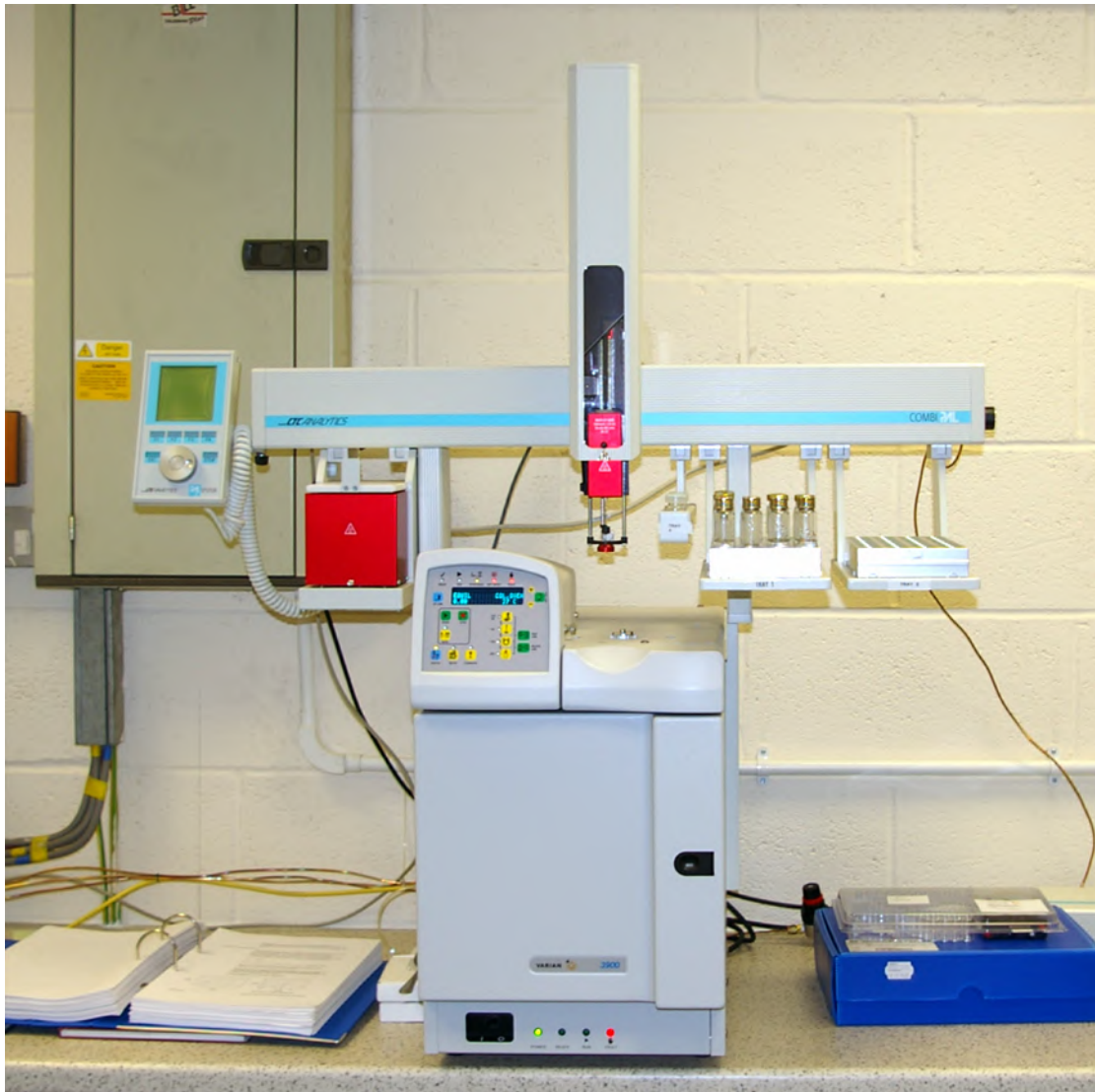

**Varian Headspace GC.**

## Chapter 4 GC-MS

The sample is dissolved in a suitable solvent (e.g. hexane or cyclohexane) and volumes less than 1  $\mu\text{l}$  are introduced into the gas chromatograph inlet using helium as the carrier gas. The mixture is separated on the capillary column and transferred to the ionisation region of the mass spectrometer. Temperatures up to 300°C in the oven and transfer regions can be used to volatilise substances. Compounds that will not volatilise under these conditions can be analysed by the direct insertion of the probe so bypassing the GC inlet.

The GC and MS parameters are computer controlled. Capillary GC columns are connected directly into the MS. Electron Ionisation (EI) provides molecular ion and mass fragmentation information, and computer comparison with library fragment spectra leads to direct identification of components in many cases. Chemical ionisation could be used for materials that are unstable thermally or under electron bombardment.

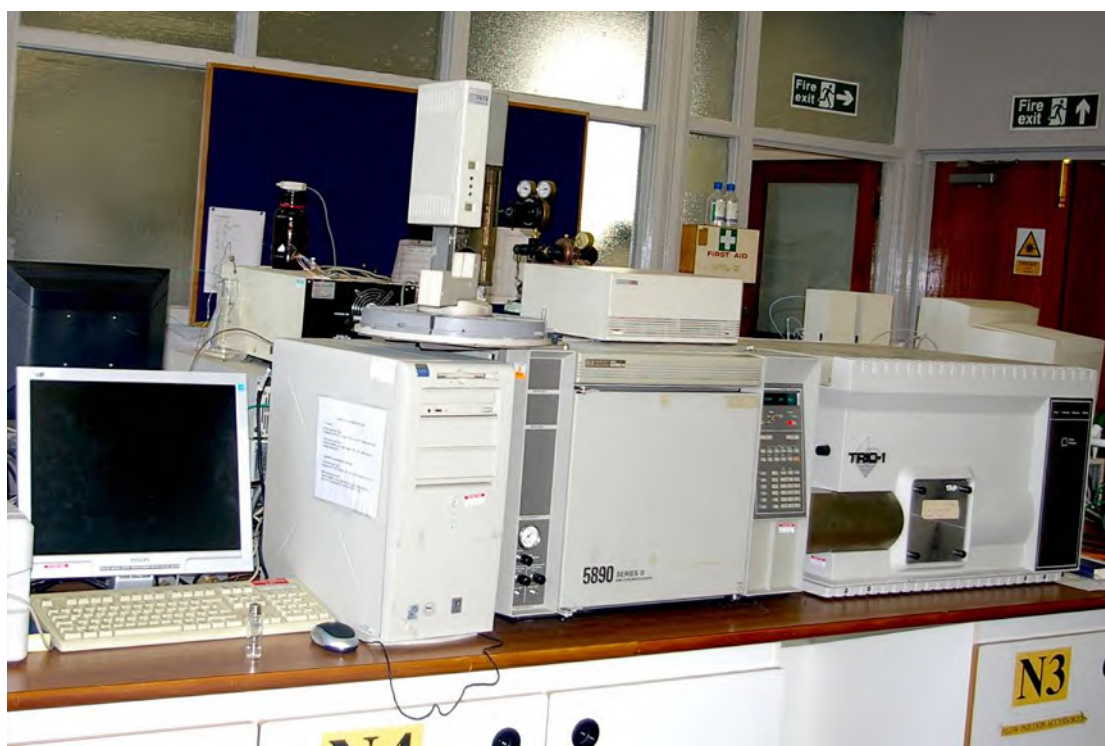

**Hewlett Packard HP Trio-1 GC-MS**



**Hewlett Packard HP Trio-1 Mass spectrometer**

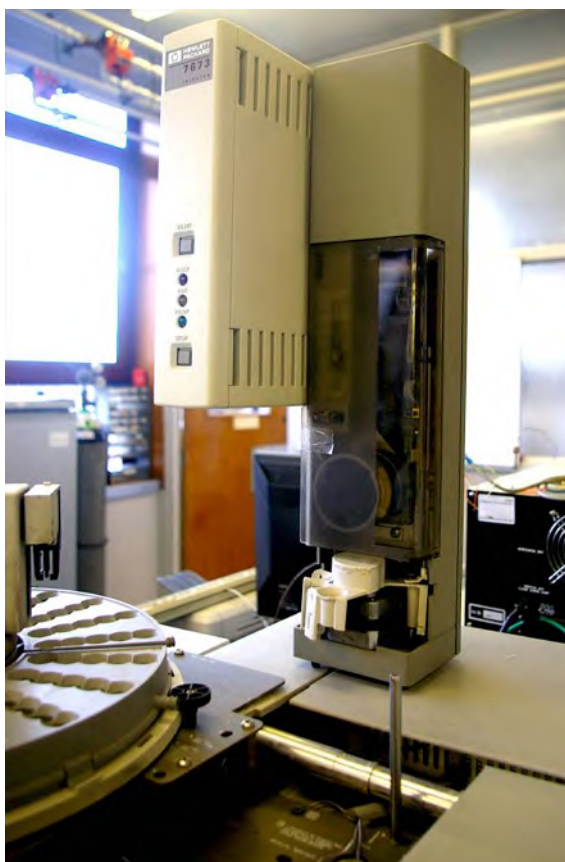

**Autosampler for the Hewlett Packard HP Trio-1 GC-MS**



**Hewlett Packard 5890 GC Oven  
for the Hewlett Packard HP  
Trio-1 GC-MS**

Total Ion Chromatograph (TIC), with the total ion current on the y-axis and the retention time on the x-axis, gives an output similar to a chromatogram but any components from the mixture can be selected and their mass spectrum displayed. The components can be identified by the interpretation of the recorded mass spectra and the identifications confirmed by using the library search facilities of the data system. A list of possible substances is produced with a percentage that indicates how well the spectra are matched against the unknown. Subtraction of background spectra can be performed to clean up otherwise imperfect spectra. To improve the selectivity, selective ion monitoring (SIM) could be performed where a particular  $m/z$  value is chosen and the data collected are displayed as a chromatogram.

The fragmentation pattern is particular to a compound, just like a fingerprint. Generally, matching only the seven most abundant ions to a reference standard held in the library is sufficient for identification.

## Chapter 5

# High Performance Liquid Chromatography

High-performance liquid chromatography (HPLC) is used in almost all sectors including the chemical industry, the screening of antibiotics in food of animal origin, trace analysis in environmental chemistry, pharmacy and biochemistry. It separates compounds dissolved in solution, and is primarily a quantitative method of analysis for non-volatile organic compounds.

### 5.1 Instrumentation

HPLC instruments consist of a reservoir of mobile phase, a pump, an injector, a separation column, and a detector as shown in Figure 9. Compounds are separated by injecting a plug of the sample mixture usually 5-25 microlitres onto the column. The different components in the mixture pass through the column at different rates due to differences in their partitioning behaviour between the mobile liquid phase and the stationary phase.

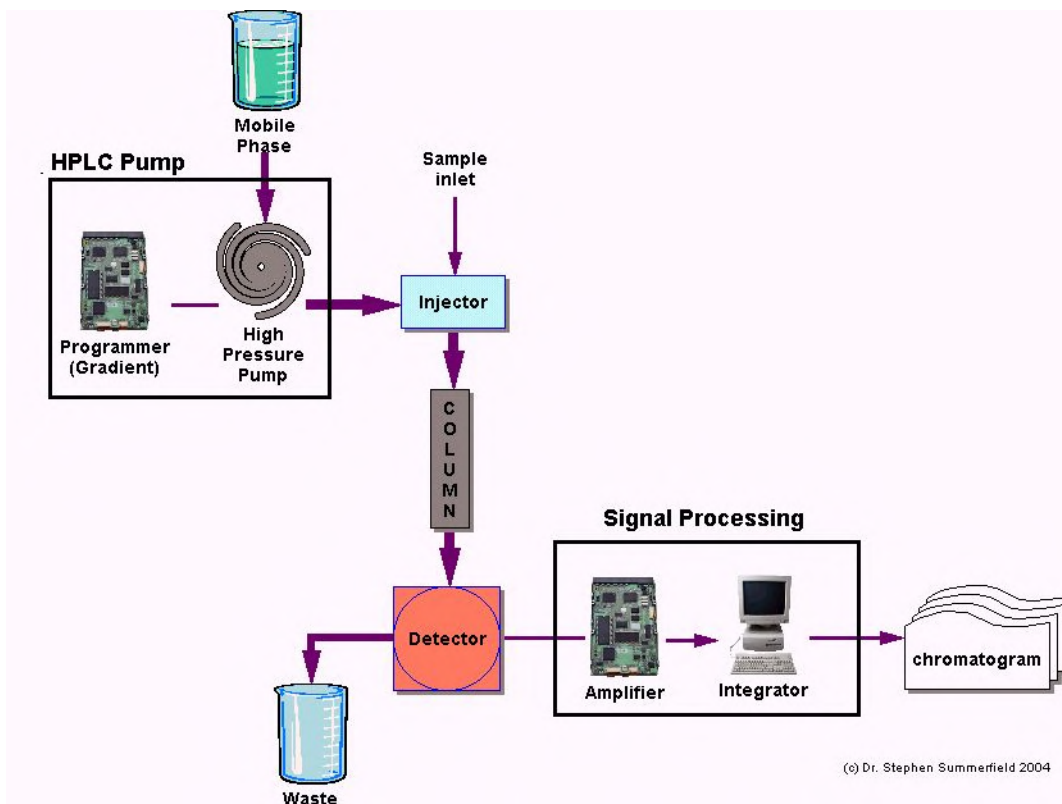
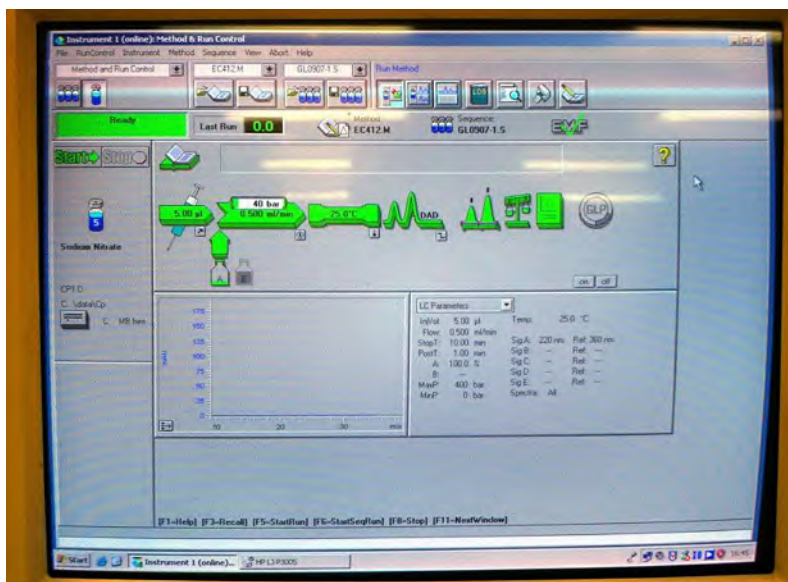
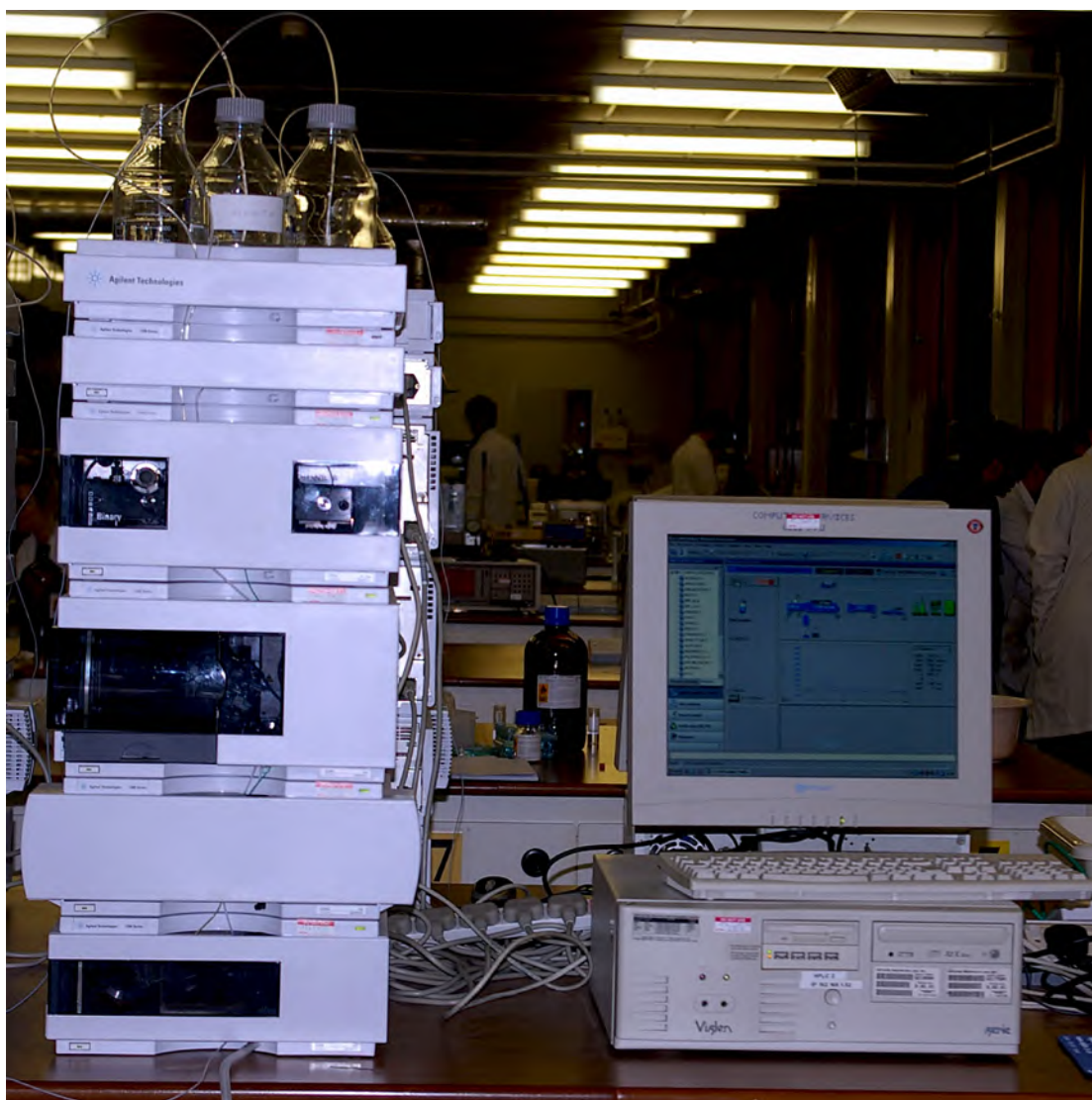

Figure 9: A schematic diagram of a HPLC

# Introduction to Chromatography



Computer controller screen for the Agilent 1200 Series HPLC



Agilent 1200 Series HPLC System



The constituents of a sample can be identified by comparison of retention times (i.e. time taken to pass through the column) with those of known standards run under the same conditions. UV/visible spectra of separated compounds recorded using a photodiode array detector can also be used as an aid to identification. Components can be quantified by comparison of peak areas with standards of known concentration.

Solvents must be degassed to eliminate formation of bubbles. The pumps provide a steady high pressure with no pulsating, and can be programmed to vary the composition of the solvent during the course of the separation. The liquid sample is introduced into a sample loop of an injector by the auto-sample. After the loop is filled, the injector valve is automatically turned to inject the sample into the stream by placing the sample loop in line with the mobile phase tubing. The column effluent flows into a detector system, of which there are a number of types.

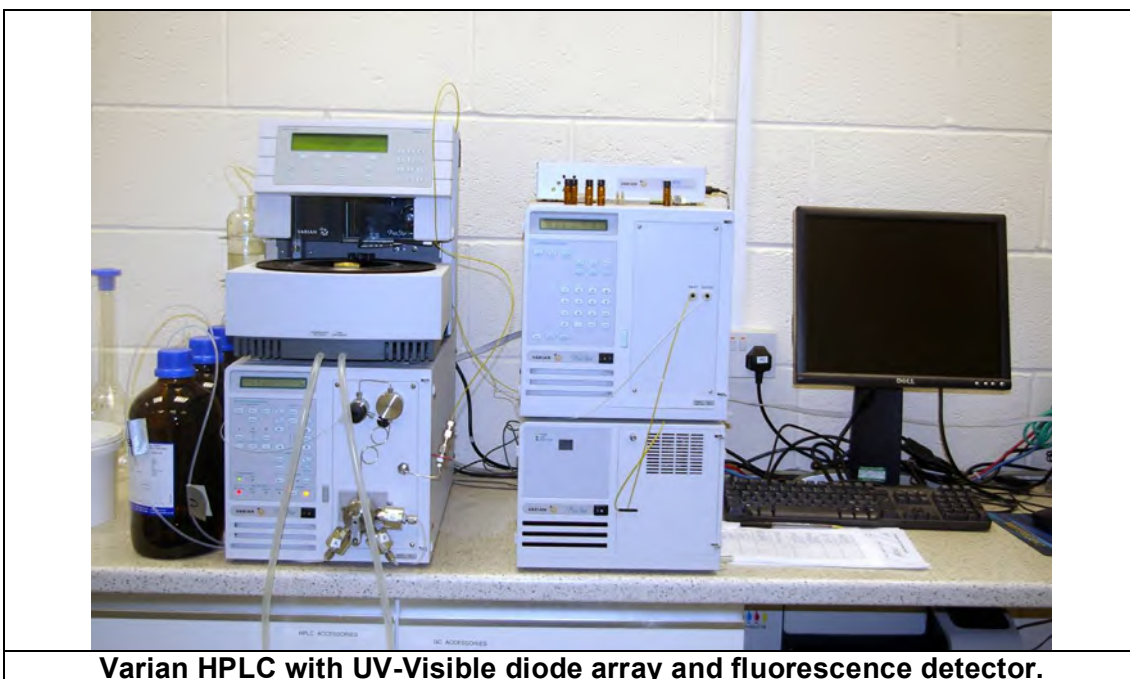

## 5.2 HPLC columns

These are normally constructed of stainless steel tubing, typically 10-30 cm in length and 3-5 mm inner diameter. The stationary phase is chemically or physically bonded to the packing material, normally 3-10  $\mu\text{m}$  silica particles.

- Reversed-phase HPLC uses a relatively non-polar stationary phase of surface modified silica support (e.g. octadecyl silanised (ODS) C18) and polar mobile phase, such as binary or tertiary mixtures of water with acetonitrile, or methanol. Reversed-phase chromatography is the most common form of liquid chromatography, primarily due to the wide range of analytes that can dissolve in the mobile phase.
- Normal-phase HPLC uses a polar stationary phase and non-polar organic solvent, such as n-hexane or isopropyl ether as the mobile phase. It separates by polarity so poorly discriminates homologues. The stationary phase is a bonded siloxane with a polar functional group, such as cyano or amino. The solvent elution in reversed-phase is usually the opposite of that in normal phase liquid chromatography. In other words, polar compounds are eluted first.

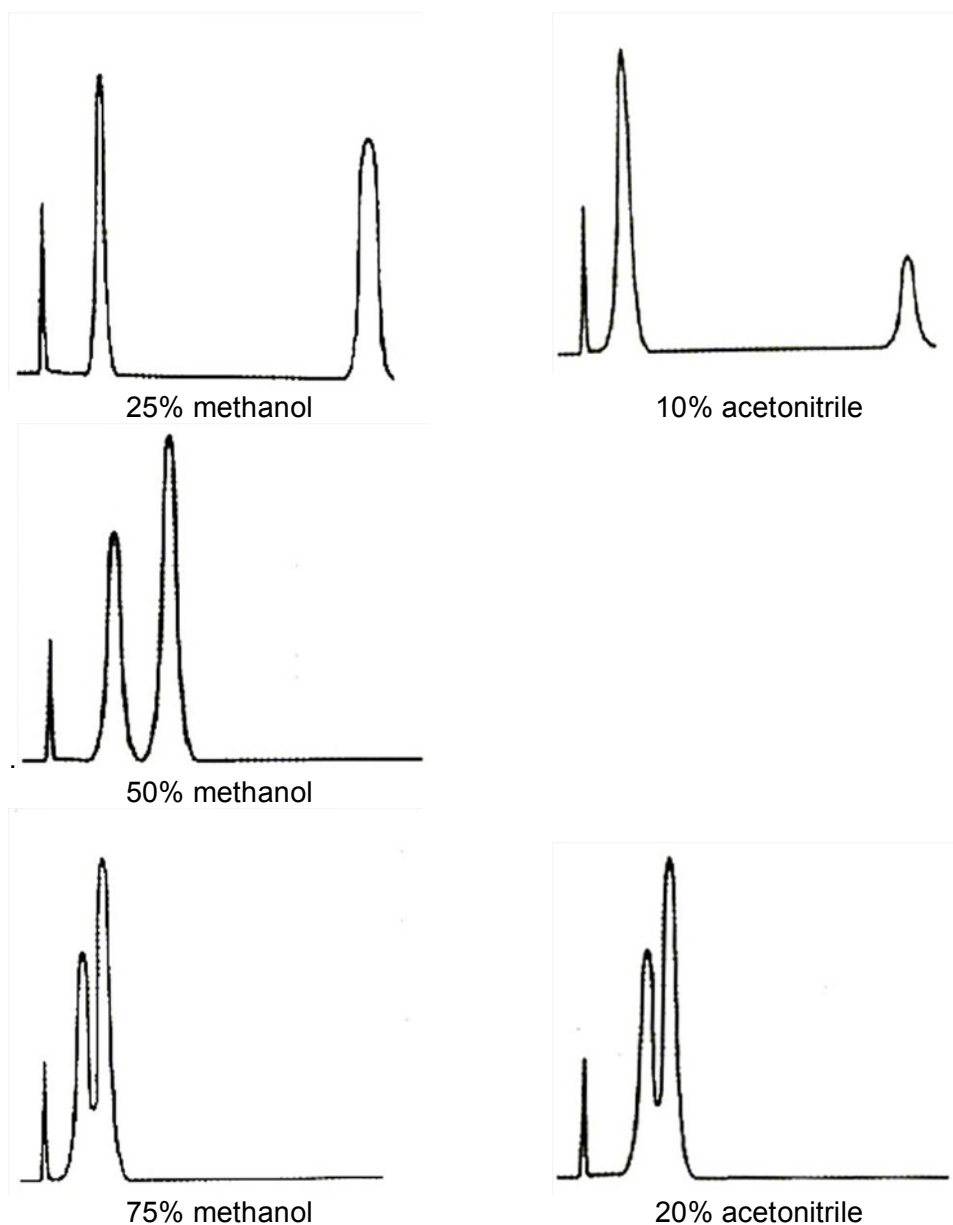

**Figure 10: Selection of mobile phase for reversed-phase HPLC. Two vitamins analysed on a 25cm reversed-phase ODS (octadecylsilyl) column using various aqueous methanol and acetonitrile mobile phases. (S. Summerfield, unpublished)**

### 5.3 Detectors

The presence of analytes in the column effluent is recorded by one (or more) of the following detection methods.

**Table 6: HPLC Detectors**

HPLC Detectors	Notes
Diode Array	Allows detection at multiple wavelengths so can give spectra for individual components for identification.
UV-visible	This is the most common detector. The mobile phase must not absorb at the analytical wavelength.
Fluorescence	Highly selective and sensitive detector e.g. polyaromatic hydrocarbons (PAHs) down to ppb levels.
Refractometer	Universal detector but has low sensitivity and is temperature sensitive. Useful for analytes that do not absorb in the UV-Visible region and predominantly used for Gel Permeation Chromatography (GPC).
<b>Detectors yielding structural information</b>	
Mass spectrometry	Very powerful, selective and sensitive method. A fragmentation spectrum of each eluting compound is produced. With the use of total ion current (TIC) or selective ion monitoring (SIM) a chromatogram is obtained that represents the compounds eluting from the column.
<b>Electrochemical</b>	
Amperometric	Very selective and sensitive for easily oxidised species such as amines and phenols down to ppb levels.
Conductivity	Flow rate and temperature sensitive. Used in Ion Chromatography (IC) for anions and cations.

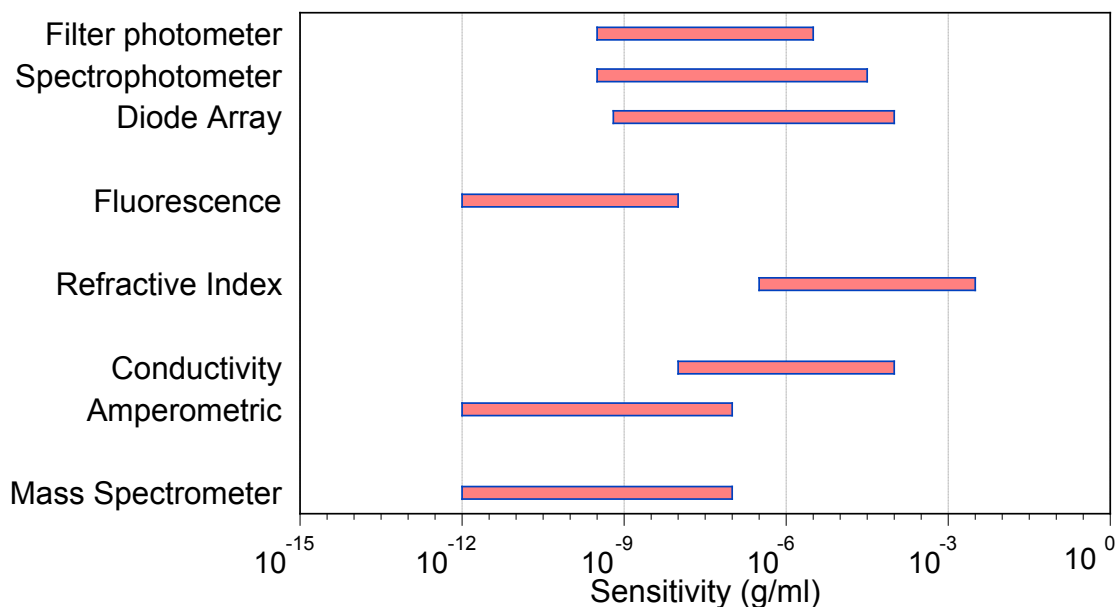

**Figure 11: Sensitivity of HPLC Detectors**

## Chapter 6

# Ion Exchange Chromatography

Ion exchange is the exchange of ions of like sign between a solution and a highly insoluble solid body in contact with it. The solid (ion-exchanger) contains ions of its own and for the exchange to proceed sufficiently rapidly, the ion-exchanger must have an open, permeable structure so that both ions and solvent molecules can move freely in and out.

Although some naturally occurring compounds such as zeolites and clay minerals have ion-exchange properties, in analysis only synthetic ion-exchangers are important.

**Cation-exchange resin** is obtained by the co-polymerisation of styrene and a small amount of divinylbenzene, followed by sulphonation. Thus a typical ion-exchange resin consists of polymeric chains, held together by links crossing from one polymer chain to another to give a polymeric skeleton.

**Anion-exchange resin** may be prepared by co-polymerisation of styrene and divinylbenzene followed by chloromethylation (introduction of the  $-\text{CH}_2\text{Cl}$  group) and interaction with a base such as trimethylamine.

The basic requirements of a useful resin are:

1. It must be sufficiently cross-linked to have only a negligible solubility.
2. It must be sufficiently hydrophilic to permit diffusion of ions through the structure at a finite and usable rate.
3. It must contain a sufficient number of accessible ion-exchange groups and must be chemically stable.
4. The swollen resin must be denser than water. The action of a cation-exchange resin is represented below:

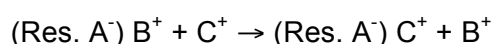

i.e. ions  $\text{C}^+$  in solution are exchanged for ions  $\text{B}^+$  bound to the resin. The extent of the exchange depends on the equilibrium constant for the reaction. A similar equation can be formulated for an anion-exchange resin.

### **6.1 Separation of Mixtures using Ion-Exchange**

Ion-exchange resins may be used for complete substitution of ions, as in the case of resins for producing deionised water, where anions are exchanged for  $\text{OH}^-$  and cations for  $\text{H}^+$ . Ions in a mixture may also be separated if they have different affinities for the resin, i.e. the equilibrium constants in the reaction above are different for a series of ions C, D, E. This is known as ion-exchange chromatography. Separation may also be achieved by selective removal of ions from the exchanger after the ions in a mixture have been bound to the resin. Resins may be regenerated by washing with a concentrated solution of the counter ion  $\text{B}^+$  (see above equation).

## 6.2 Ion Chromatography

This is a form of ion exchange chromatography for the separation of inorganic and some organic cations and anions with conductometric detection after suppressing (removing) the mobile phase electrolyte.

**Stationary Phase** consists of porous-layer beads that have cation or anion exchange sites.

**Mobile Phase** contains electrolytes such as  $\text{Na}_2\text{CO}_3$  or  $\text{NaHCO}_3$  for anions and  $\text{HCl}$  or  $\text{CH}_3\text{SO}_3\text{H}$  for cations.

**Suppressor** – The detection of low levels of ionic solutes in the presence of an eluting electrolyte is not feasible unless the latter is removed by the suppressor and converted to the barely conductive carbonic acid ( $\text{H}_2\text{O}$  &  $\text{CO}_2$ ). This leaves the solute ions as the only ionic species enabling them to be sensitively detected.



**Metrohm 792 Basic Ion Chromatography**

### Column reaction

The following equations summarise the reaction of an anion exchange column in  $\text{Na}^+\text{HCO}_3^-$  mobile phase.

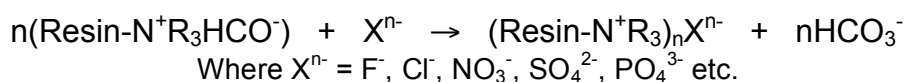

## Introduction to Chromatography

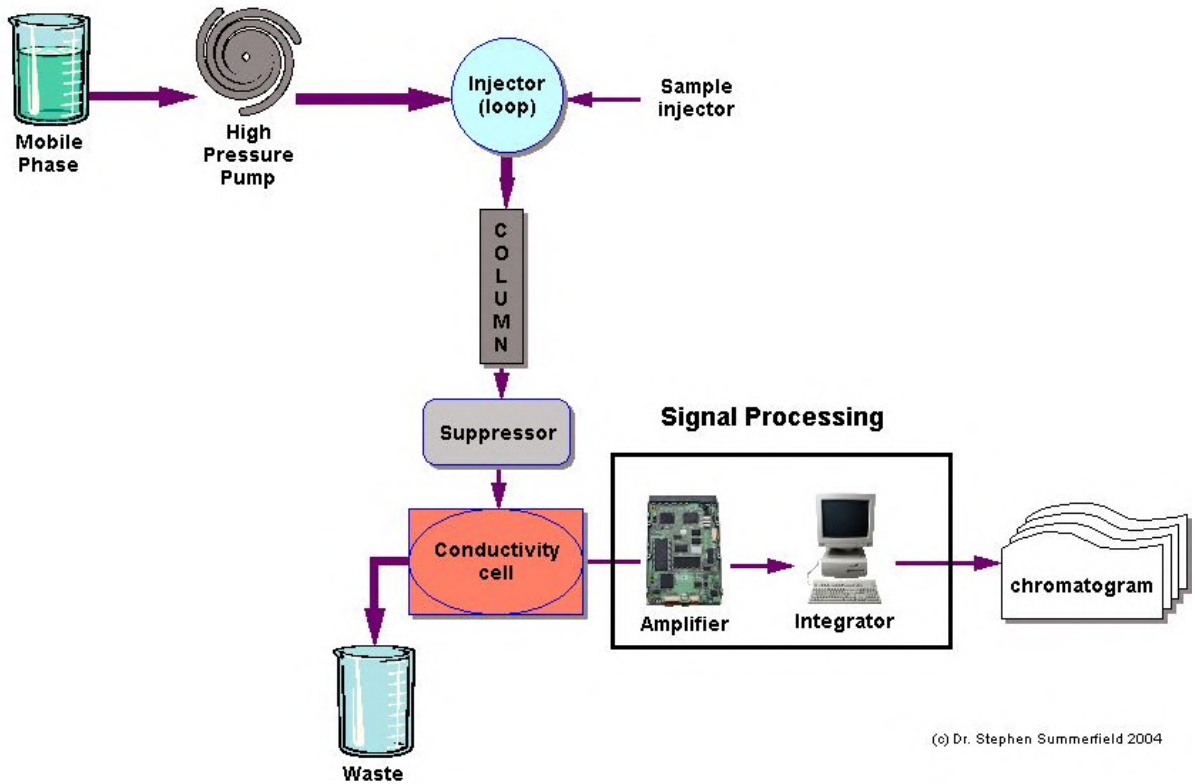
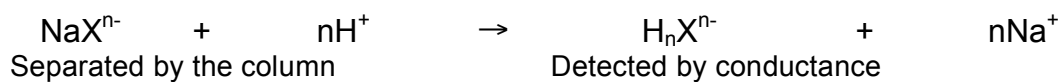
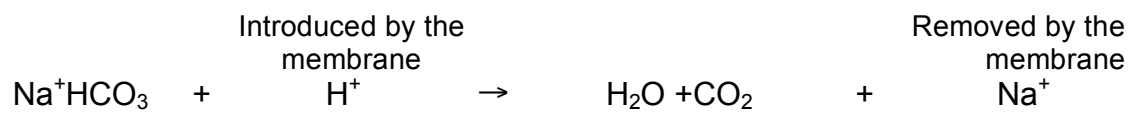

Figure 12: Ion Chromatograph



Inside the Metrohm 792 Basic Ion Chromatography system

*Suppressor reactions*



*Detection*

Conductivity measurement is used as a universal detector in ion-chromatography, as in aqueous solutions ions exhibit conductivity proportional to their concentration.

## Bibliography

- Dean J.R., Jones A.M., Holmes D., Reed R., Meyers J. and Jones A. (2002), *Practical Skills in Chemistry*, Prentice Hall.
- Harris, Daniel C. (2006), *Quantitative Chemical Analysis*, 7<sup>th</sup> Edition, W. H. Freeman
- Ho W.F., Prichard E., Stuart B. (2003) *Practical Laboratory Skills Training Guides: High Performance Liquid Chromatography*, RSC.
- Kellner R., Mermet J.-M., Otto M. Widmer H.M. (1998) *Analytical Chemistry*, Wiley-VCH.
- Lindon J.C., Tranter G.E. and Holmes J.L. (2000) *Encyclopaedia of Spectroscopy and Spectrometry*, Volumes 1-3, Academic Press.
- Mermet, Jean-Michel, Otto, Matthias and Valcarcel Cases, Miguel (2005), *Analytical chemistry : a modern approach to analytical science*, 2<sup>nd</sup> Edition, Wiley-VCH
- Meyers, R.A. (Ed.), (2000), *Encyclopaedia of Analytical Chemistry: Theory and Instrumentation*, Volumes 1-15, J. Wiley and Sons Ltd., London.
- Rouessac F. and Rouessac A., (2000), *Chemical Analysis*, Wiley.
- Shugar G.J. and Dean J.A. (1990), *The Chemist's Ready Reference Handbook*, McGraw-Hill.
- Skoog, Douglas A. and Holler, F. James (2007), *Instrumental Analysis Principles.*, 6<sup>th</sup> Edition, Brooks/Cole
- Stuart B. and Prichard E. (2003) *Practical Laboratory Training Guides: Gas Chromatography*, RSC.
- Townshend A. (1995) *Encyclopaedia of Analytical Science*, Volumes 1-10, Academic Press, London.
- Wayne R.P. (1994) *Chemical Instrumentation*, Oxford Chemistry Primers.
- Willard H.H., Merritt L.L., Dean J.A. and Settle F.A. (1988), *Instrumental Methods of Analysis*, 7<sup>th</sup> edition, Wadsworth Publishing Company, California.

## Acknowledgements

Dr. Helen Reid, Dr. Barry Sharp, Dr. Brenden Theaker and the staff of Loughborough University.